



A GIBRALTAR INDUSTRIES COMPANY 

VINYL STUCCO ACCESSORIES



TRANSFORMING MATERIALS

into products that make a better world

TABLE OF CONTENTS

Stucco Corner BeadsPage 1	Stucco Screeds Page 9
Vinyl Corner Bead	CI Weep Trac™
Vinyl Wide Flange Corner Bead	Drip Screed
Vinyl Arched Corner Bead	Horizontal Drip Screed
Vinyl Bull Nose Corner Bead	
Stucco Casing Beads Page 2	Stucco Reveals Page 10
E-Z Bead® Vinyl Casing Bead	Stucco Reveal
Vinyl Casing Bead	Stucco Reveal Intersections and Corners
Vinyl Solid Wide-Flange	"F" Channel Reveal..... Page 11
Vinyl Extra-Long Flange	Angled Stucco Reveal
Casing Bead..... Page 3	Chamfered Reveal..... Page 12
Vinyl Angled Casing Bead	Drip Screed Reveal
Vinyl Banding Bead	Window and Door Drip Edge Page 13
Stucco Control Joints Page 4	2-Piece Shadow Reveal
Vinyl M-Type Control Joint	
Vinyl Control Joint	Stucco Soffit Vents Page 14
Stucco Expansion Joints Page 5	Vinyl Continuous Stucco Soffit Vent (1-Piece)
Outside Corner Expansion Joint	Vinyl Continuous Stucco Shadow Vent (1-Piece)
Inside Corner Expansion Joint	Vinyl Stucco Soffit Vent (3-Piece) Page 15
Vinyl 2-Piece Expansion Joint Page 6	
Male Expansion Component	Soffit Vent Panels Page 16
Female Expansion Component	Vinyl Soffit Vent Panels
Vinyl Angles	Vinyl Shadow Vent Panels
Stucco Weep ScreedsPage 7	
Foundation Weep Screed	AMICO Manufacturing and Distribution Centers Back Cover
Wall Screed	
Mid-Wall Weep Screed Page 8	
Weep Screed Extended	

QUALITY PRODUCTS – AROUND THE GLOBE



A GIBRALTAR INDUSTRIES COMPANY 

ALABAMA METAL INDUSTRIES CORPORATION

3245 Fayette Avenue • Birmingham, AL 35208

Phone (205) 787-2611 • (800) 366-2642 • Fax (205) 786-6527

www.amicoglobal.com

STUCCO CORNER BEADS

Vinyl Corner Bead reinforces exterior stucco corners with durable, straight and rust-free vinyl corners. The addition of stiffener ribs and slotted nailing holes makes these products easy and quick to install level and straight. 10' standard length.

Product No.	Description	Leg "A"	Leg "B"	Box Count
AMX-1	Equal Leg	2½"	2½"	50
AMX-1-X	Equal Leg	1½"	1½"	50
AMX-2	Equal Leg	2¾"	2¾"	40

Product No.	Description	Leg "A"	Leg "B"	Box Count
AMX-1-IR	Unequal Leg	2½"	1½"	50
AMX-2-IR	Unequal Leg	2¾"	1½"	40

Vinyl Wide Flange Corner Bead reinforces exterior stucco creating irregular shapes such as under window ledges.

Product No.	Description	Leg "A"	Leg "B"	Box Count
AMX-1-WF	Equal Leg	4"	4"	30

Vinyl Arched Corner Bead offers the same quality and performance as our other fine corner bead products with the added benefit that it comes pre-notched to curve to most construction radiuses. 10' standard length.

Product No.	Ground	Leg Dimensions	Box Count
AMX-1-Arch	Any	2½" x 2½"	50
AMX-2-Arch	Any	2¾" x 2¾"	40

Vinyl Bull Nose Corner Bead provides a 3/4" radius with similar damage resistant qualities as that of metal bull nose corner bead. This vinyl bead offers the added advantages of being rust proof, lightweight and easy to install. 10' standard length.

Product No.	Ground	Leg Dimensions	Box Count
AMX-1-BN	Any	2½" x 2½"	20

Items are assembled after order is placed and require additional lead time.

NOTE: All joints should be embedded in sealant and sealed after installation if necessary.

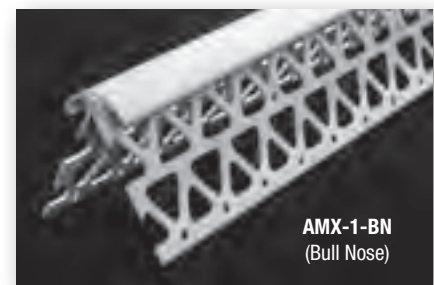
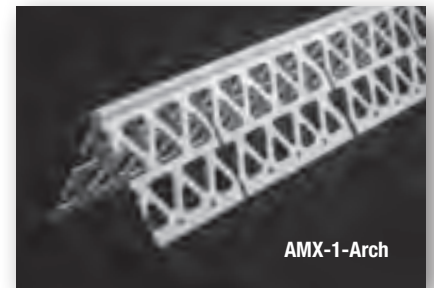
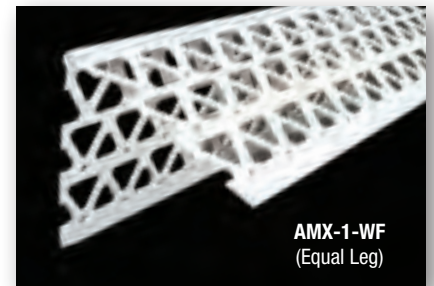
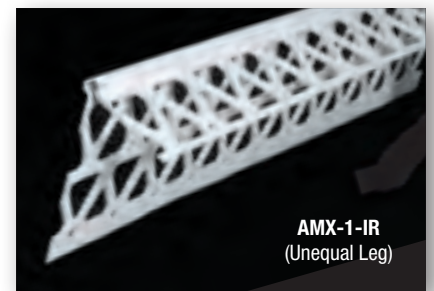
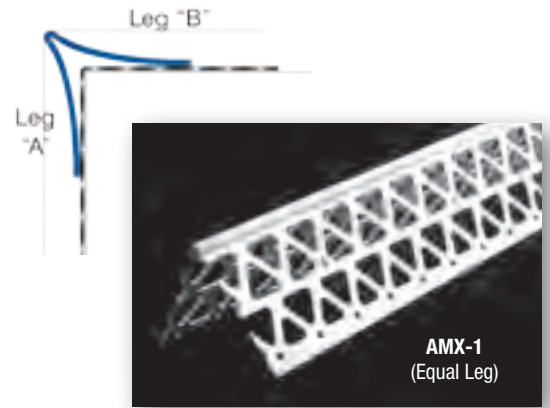

STUCCO CASING BEADS

E-Z Bead® Vinyl Casing Bead is designed with a built-in flexible strip for straight and uniform spacing around window and door frames or any other point where stucco meets a dissimilar material (e.g., soffits, fascia board, etc.) This flexible spacing strip is lined with a bond breaking tape that allows for two-sided adhesion, which eliminates the need for a backer rod. (U.S. Patent No. 7,874,123)

Product No.	Ground	Flexible Backer Rod	Nail Flange Height	Box Count
AM66-EZ-500	1/2"	3/8"	1 3/4" perf flange	50
AM66-EZ-580	5/8"	3/8"	1 3/4" perf flange	50
AM66-EZ-750	3/4"	3/8"	1 3/4" perf flange	50
AM66-EZ-780	7/8"	3/8"	1 3/4" perf flange	50

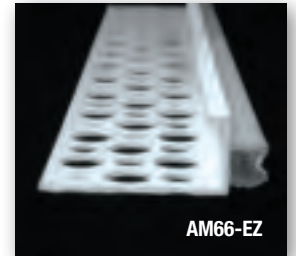

Vinyl Casing Bead is often referred to by the industry as a “plaster stop” because it is used to terminate plaster or stucco. AMICO vinyl casing beads are strong and durable to give maximum protection to this highly vulnerable stucco area. Casing beads larger than 1” have additional reinforcement in the ground flange for extra strength. Vinyl casing bead is also available with 1/8” weep holes punched at 6” intervals. This product is not intended to be used in lieu of a foundation weep screed. 10’ standard length.

Product No.	Dimensions	Ground	Box Count	Weep Option
AM66-250	1 3/4" Perf. Flange	1/4" Regular	100	No
AM66-380	1 3/4" Perf. Flange	3/8" Regular	100	Yes
AM66-500	1 3/4" Perf. Flange	1/2" Regular	100	Yes
AM66-580	1 3/4" Perf. Flange	5/8" Regular	100	Yes
AM66-750	1 3/4" Perf. Flange	3/4" Regular	75	Yes
AM66-780	1 3/4" Perf. Flange	7/8" Regular	75	Yes
AM66-1000	1 3/4" Perf. Flange	1" Regular	75	Yes
AM66-1250	1 3/4" Perf. Flange	1 1/4" Deep	50	Yes
AM66-1500	1 3/4" Perf. Flange	1 1/2" Deep	50	Yes
AM66-2000	1 3/4" Perf. Flange	2" Deep	40	Yes

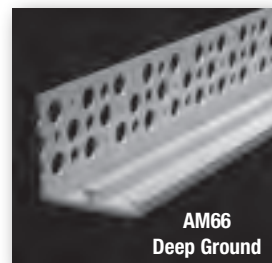

Vinyl Solid Wide-Flange Casing Bead is used as a stop with a solid flange. This product can be applied at window heads as well as at transitions from roof lines and foundation lines. It includes weep holes punched in the bottom at 6” intervals. 10’ standard length.

Product No.	Flange Height	Ground "A"	Box Count
AM66-WFWC-500 Custom	3 1/2"	1/2"	40
AM66-WFWC-780 Custom	3 1/2"	7/8"	40



Vinyl Extra-Long Flange Casing Bead has the same design as our AM66 beads, except with a wider, perforated flange. 10' standard length. Available with weep holes or without.

Product No.	Flange Height	Ground "A"	Box Count	Weep Option
AM66-XWF-580	5"	5/8"	40	Yes
AM66-XWF-750	5"	3/4"	40	Yes

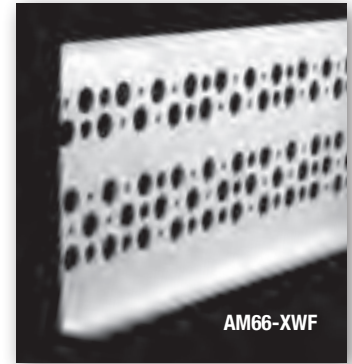

Vinyl Angled Casing Bead is used to form the top edge of a horizontal wall band. The 75-80 degree down-sloping angle permits water to move away from the top edge of the wall and away from the building facade. 10' standard length.

Product No.	Dimension A	Ground B	Box Count
AM66-Angled-1000	1 3/4" Flange	1"	75
AM66-Angled-1250	1 3/4" Flange	1 1/4"	50
AM66-Angled-1500	1 3/4" Flange	1 1/2"	50



Vinyl Banding Bead is used to form the sharp clean edges of horizontal bands. A double ground or screed lip has been provided to facilitate the screeding of the adjoining stucco. Different thicknesses of stucco are applied creating the band. Our double ground allows for a true, straight and clean band for stucco applications. 10' standard length.

Product No.	Dimensions	Ground A	Ground B
AMBB-750-500	1 3/4" Flange	3/4"	1/2"
AMBB-1000-500	1 3/4" Flange	1"	1/2"
AMBB-1500-500	1 3/4" Flange	1 1/2"	1/2"
AMBB-1500-750	1 3/4" Flange	1 1/2"	3/4"



STUCCO CONTROL JOINTS

Vinyl M-Type Control Joint with (optional) Removable Tape

10' standard length.

Product No.	Perforated Flange Dimensions	Ground "A"	Box Count
AMCJM-380	4" overall	3/8"	35
AMCJM-500	4" overall	1/2"	35
AMCJM-580	4" overall	5/8"	30
AMCJM-750	4" overall	3/4"	25
AMCJM-780	4" overall	7/8"	20



Vinyl Control Joint with Removable Tape is an *improved version* of the "M" type control joint. This Control Joint provides returns to better lock into the stucco. These joints can be ordered without the removable tape.

10' standard length.

Product No.	Ground "A"	Perforated Flange Dimensions "B"	Box Count
AMCJX-250	1/4"	2 1/2"	50



Control joints refer to one-piece accessories designed to create artificial planes of weakness where minor stresses can dissipate without forming cracks. Their placement is a function of the designer and should be located on the drawings.

Control joints should be wire tied to the lath. They are a function of the plaster assembly, not the structure. For this reason AMICO can only recommend the traditional point of view that control joints are to be wire-tied to the lath and not fastened to the structure. By wire-tying down one side of the joint and then tying the other side, the lath can be brought taut creating a preferred substrate for the application of the finish. AMICO further recommends the lath control joint be wire-tied on top of the lath. Moist curing is the means to hydrate the brown coat prior to the finish coat. Its purpose is to assure sufficient water remains in the plaster to effect hydration that develops strength, enhancing the strain capacity of the finish. Moist curing helps mitigate many of the ills that can lead to cracks. All aspects of lathing and plastering go far beyond the application of plaster to a wall or soffit. It is a craft that requires skill, artistry, experience, and good judgement to install the finish that performs for the life of the structure. One must understand that Codes and Standards are only a minimum requirement. A successful installation goes far beyond the brief comments, though AMICO feels these guidelines experienced through time can offer the best opportunity for a successful installation.

NOTES:

Removable tape has been provided to insure a clean joint after stucco application. All joints should be embedded in sealant and sealed after installation if necessary. **If the joints are ordered without the removable tape**, it will be the contractor's responsibility to keep the joint clean of wet stucco and any other debris.

STUCCO EXPANSION JOINTS

Outside Corner Expansion Joint (3-Piece) is designed to relieve stress in stucco at outside corners where excess movement or shrinkage might result in cracked stucco. 10' standard length.

Product No.	Ground "A"	Box Count
AMXJO-500	1/2"	15
AMXJO-580	5/8"	15
AMXJO-750	3/4"	15
AMXJO-780	7/8"	12

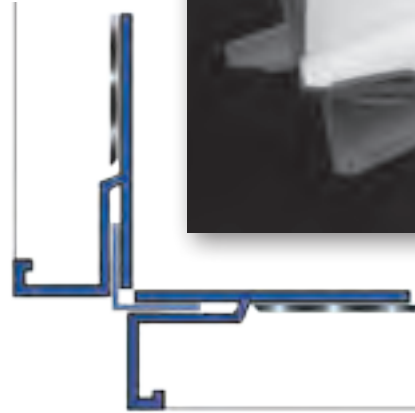

Inside Corner Expansion Joint (3-Piece) is designed to relieve stress in stucco at inside corners where excess movement or shrinkage might result in cracked stucco. 10' standard length.

Product No.	Ground "A"	Box Count
AMXJI-500	1/2"	15
AMXJI-580	5/8"	15
AMXJI-750	3/4"	15
AMXJI-780	7/8"	15

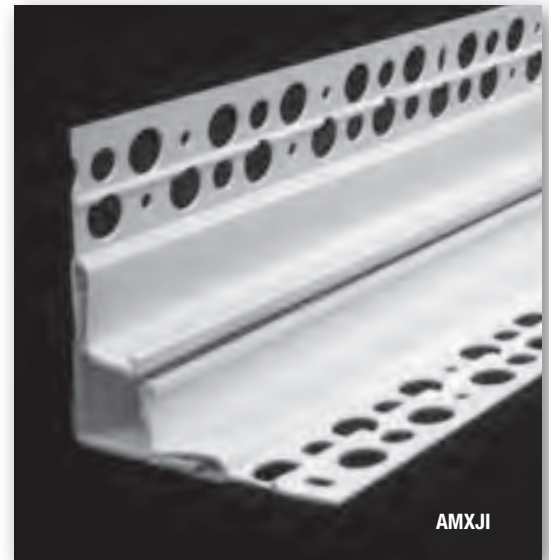
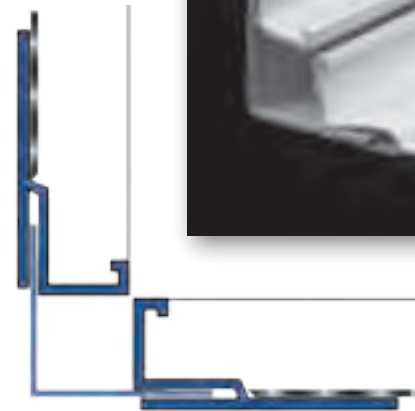

NOTES:

All joints should be embedded in sealant and sealed after installation.

Items are assembled after order is placed and require additional lead time.

STUCCO EXPANSION JOINTS

Vinyl 2-Piece Expansion Joint with 1/2" Reveal is designed to relieve stresses in stucco wall and ceiling areas where a greater than normal degree of movement might occur. This joint allows for movement in two different planes and is recommended at through-wall construction joints and where two different framing materials meet. If AMEJ is installed horizontally, place the female component on the top side and the male component on the bottom side. 10' standard length.

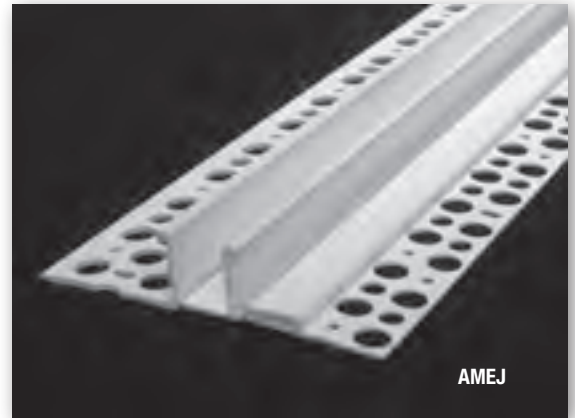

AMEJ



Product No.	Joint Width	Reveal	Ground	Box Count
AMEJ380-500	Adjustable 1/4" to 1/2"	1/2"	3/8"	25
AMEJ500-500	Adjustable 1/4" to 1/2"	1/2"	1/2"	25
AMEJ580-500	Adjustable 1/4" to 1/2"	1/2"	5/8"	25
AMEJ750-500	Adjustable 1/4" to 1/2"	1/2"	3/4"	25
AMEJ780-500	Adjustable 1/4" to 1/2"	1/2"	7/8"	20

Male Expansion Component

is the companion part of the two-piece expansion joint and other multi-part expansion joints. Designed to relieve stucco stress in wall and ceiling areas where excessive horizontal and vertical movements might occur. 10' standard length.

Product No.	Type	Ground	Box Count
AMMEJ-500	Male	1/2"	50
AMMEJ-580	Male	5/8"	50
AMMEJ-750	Male	3/4"	50
AMMEJ-780	Male	7/8"	50

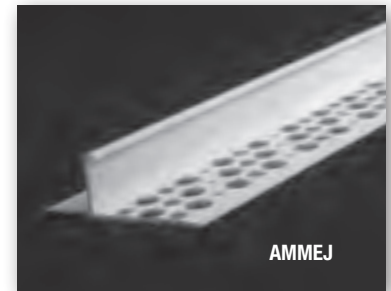

AMMEJ

Female Expansion Component

is half of the two-piece expansion joint and other multi-part expansion joints. It is used to fabricate reveals and soffit joints, which incorporate expansion. 10' standard length.

Product No.	Type	Ground	Box Count
AMFEJ-500	Female	1/2"	50
AMFEJ-580	Female	5/8"	50
AMFEJ-750	Female	3/4"	50
AMFEJ-780	Female	7/8"	50

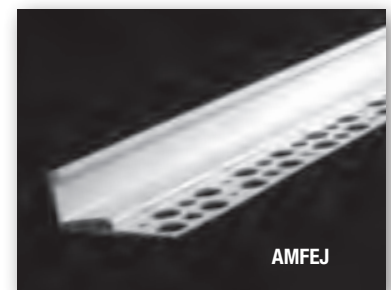

AMFEJ

Vinyl Angles are used with inside and outside corner expansion joints (can be sold separately). 10' standard length.

Product No.	Dimensions (Legs)	Box Count
AM1000-1000	1" x 1"	50



Vinyl Angle

NOTES:

All joints should be embedded in sealant and sealed after installation if necessary.

Items are assembled after order is placed and require additional lead time.

STUCCO WEEP SCREEDS

Foundation Weep Screenshot provides a straight and true screed surface at the base of stucco walls, while allowing excess moisture to escape the back of the stucco membrane. It is important for the water-resistant paper and metal lath to overlap the nailing flange of the weep screed. Check with local building codes for the proper clearance above grade. Building codes require this bead on framed walls. 10' standard length.

Product No.	Dimensions	Ground	Box Count
AMFWS-425-380	4¼"	¾"	30
AMFWS-425-500*	4¼"	½"	30
AMFWS-425-580*	4¼"	⅝"	30
AMFWS-425-750	4¼"	¾"	30
AMFWS-425-780*	4¼"	⅞"	30

*Available in standard white, as well as tan, brown or gray (on exposed areas only).

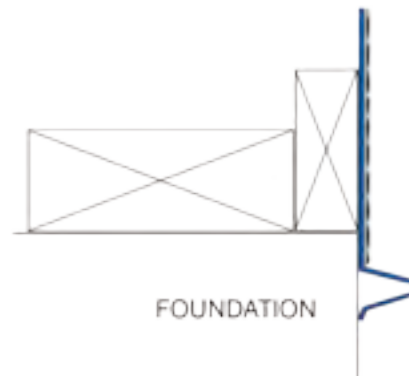

part shown here in TAN color

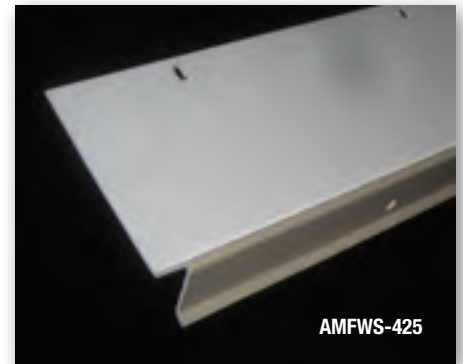

AMFWS-425

Wall Screenshot uses the same profile as the traditional Foundation Weep Screenshot, except this version is produced with a shorter (2 ⅜"), perforated attachment flange. Contact AMICO for pricing and lead time. The Wall Screenshot is ideal for stucco-to-block terminations, roof-to-wall transitions, and similar applications.

Product No.	Nail Flange	Ground	Box Count
AMFWS-P-238-500	1⅝"	½"	60
AMFWS-P-238-580	1⅝"	⅝"	60
AMFWS-P-238-780	1⅝"	⅞"	60

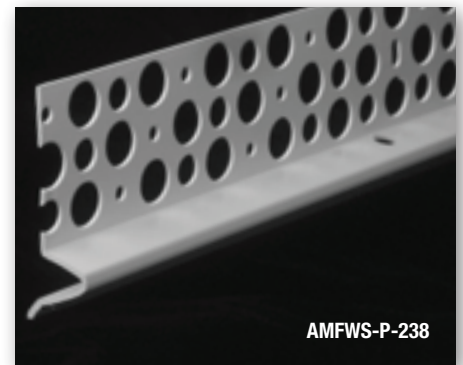
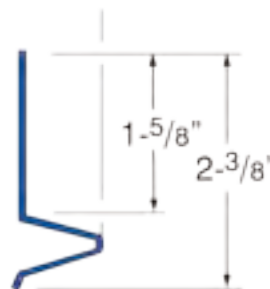

AMFWS-P-238

STUCCO WEEP SCREEDS

Mid-Wall Weep Screed performs as an unpunched weep screed allowing excess moisture to escape the back of a stucco membrane. This screed also performs as an expansion (control) joint with twin grounds. It is installed where a framed stucco surface meets a masonry (concrete block) stucco surface. This condition is common between floors on 2-story homes and at the base of a gable receiving stucco.

The unpunched flange above must be installed extending at least one inch below the framing/concrete joint. The weather barrier and lath should be installed over the solid upper flange to direct water to the foundation weep screed. The profile is manufactured with a 3½" nailing flange as required by code. 10' standard length. (Patent# 8,584,416)

Product No.	Ground A	Ground B	Box Count
AMMWS-780-500	7/8"	1/2"	15
AMMWS-780-580	7/8"	5/8"	15

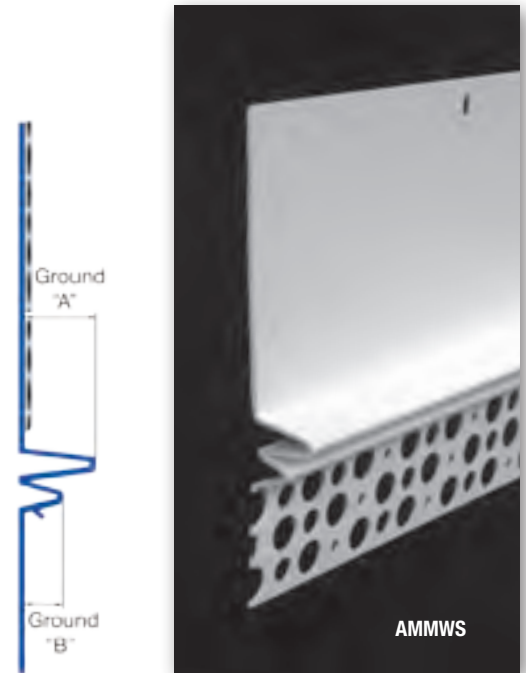

Weep Screed Extended (Return) Leg is used like a regular foundation weep screed but covers the bottom edge of the sheathing in cases where the sheathing or framing extends beyond the edge of the foundation. This protects the edge of the sheathing from moisture and insect damage and closes the gap caused by the offset. 10' standard length.

NOTE: Weep screeds are required at the base of framed walls. This profile is manufactured with a 3½" vertical nailing flange as standard.

Product No.	Overall Height	Ground	Box Count
AMFWS-L-425-500	4¼"	1/2"	30
AMFWS-L-425-780	4¼"	7/8"	30

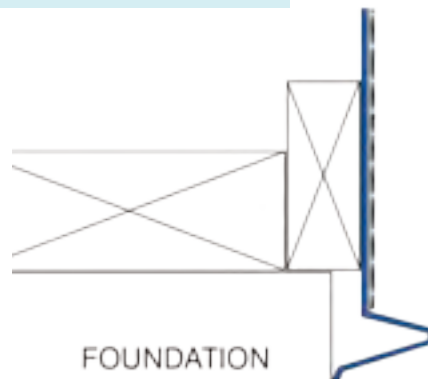
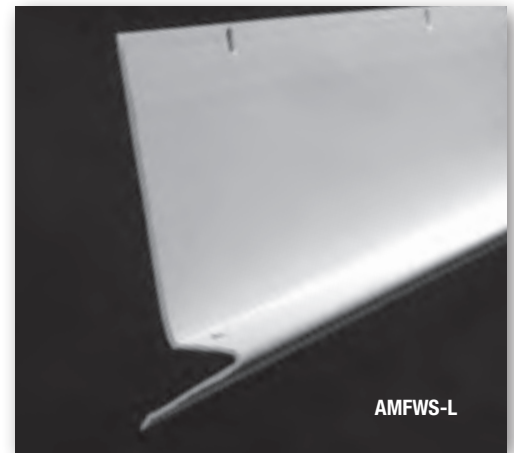

STUCCO SCREEDS

CI Weep Trac™ for Continuous Insulation applications is a new component that permits the application of stucco or thin veneer stone over rigid insulation that is attached to the outside of the building envelope when seeking to comply with the 2012 International Energy Conservation Code. AMICO's CI Weep Trac System facilitates that short return of stucco back to the wall at doors, windows, and soffits. Additionally, the CI Weep Trac is an effective foundation weep screed at the base of the wall, meeting International Building Code (IBC Chapter 25) requirements.

The 3½" nailing flange serves as a flashing when water-resistant, breathable building paper or paper-backed lath is installed over the flange. Available with holes in the "trough" to offer minor moisture weeping capabilities over window and door heads, bases of walls or other conditions that require drainage. Fire Testing: Pass, NFPA 285-Multi-Story flammability test. (Patent# D703,306S and D703,307S) The 3/4" ground will work with 5/8" hard coat systems.

Product No.	Ground	Box Count
AMCI-750	¾"	24
AMCI-P-750	¾"	24



Drip Screed with control joint has a two-piece design which allows for a drip edge in stucco. The control joint helps to relieve stress at the intersection of the soffit and fascia. 10' standard length.

Product No.	Ground	Box Count
AMDS-500-500	½"	15
AMDS-580-580	5/8"	15
AMDS-750-750	¾"	15
AMDS-780-780	7/8"	15

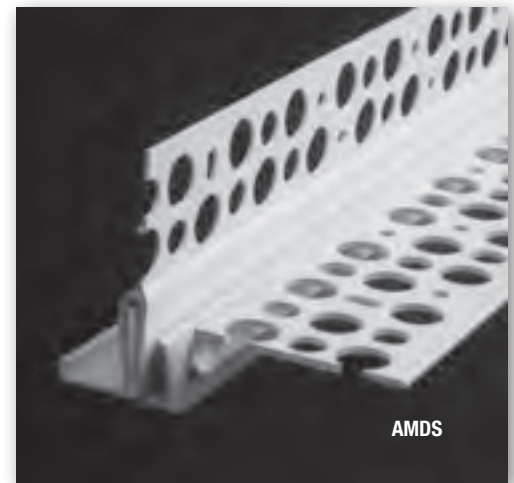

Horizontal Drip Screed is similar to the two-part drip screed, but only uses the horizontal component for special drip conditions and to relieve stress. 10' standard length.

Product No.	Ground	Box Count
AMHDS-380	3/8"	35
AMHDS-500	½"	35
AMHDS-580	5/8"	30
AMHDS-750	¾"	25
AMHDS-780	7/8"	20

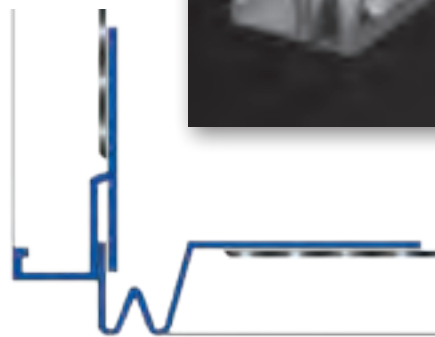

NOTES:

All joints should be embedded in sealant and sealed after installation if necessary.
Items are assembled after order is placed and require additional lead time.

STUCCO REVEALS

Stucco Reveal (available with temporary masking caps for most sizes) is used to provide architectural relief in stucco walls. This product creates breaks in stucco to create architecturally pleasing walls. This does not perform the function of a control joint because it does not allow for movement in the same way as a control joint. 10' standard length.

Vinyl Stucco
Reveal with
Temporary Cap

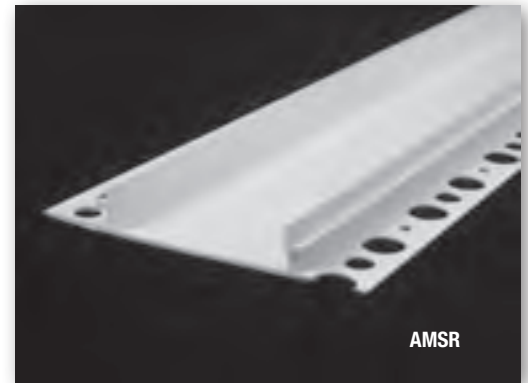

Product No.	Ground	Reveal	Width A	Box Count	Product No.	Ground	Reveal	Width A	Box Count
AMSR-500-500	1/2"	1/2"	3 1/8"	35	AMSR-580-1500	5/8"	1 1/2"	3 1/8"	20
AMSR-500-750	1/2"	3/4"	3 1/8"	35	AMSR-580-2000	5/8"	2"	4 1/8"	14
AMSR-500-1000	1/2"	1"	3 1/8"	25	AMSR-750-500	3/4"	1/2"	3 1/8"	25
AMSR-500-1500	1/2"	1 1/2"	3 1/8"	20	AMSR-750-750	3/4"	3/4"	3 1/8"	25
AMSR-500-2000	1/2"	2"	4 1/8"	20	AMSR-750-1000	3/4"	1"	3 1/8"	25
AMSR-580-500	5/8"	1/2"	3 1/8"	25	AMSR-750-2000	3/4"	2"	4 1/8"	14
AMSR-580-750	5/8"	3/4"	3 1/8"	25	AMSR-780-500	7/8"	1/2"	3 1/8"	25
AMSR-580-1000	5/8"	1"	3 1/8"	25	AMSR-780-1500	7/8"	1 1/2"	3 1/8"	17

Stucco Reveal Intersections and Corners

are available for all the reveals listed above. One-piece intersection and corner reveal assemblies are made via a patented process for extra strength and provide an uninterrupted transition for aesthetic appeal. All butt joints, ends, angles and corners should be embedded in sealant at time of installation and after installation if necessary. All angles are at 90 degrees. For ordering information, contact AMICO at 800-487-2511.



NOTE: All joints should be embedded in sealant and sealed after installation if necessary.

"F" Channel Reveal forms reveals in wall and ceiling designs, as well as addressing the juncture of dissimilar materials. This bead does not perform the function of an expansion joint because it does not allow for movement. 10' standard length.

Product No.	Ground	Reveal	Width A	Box Count
AMFR-500-500	1/2"	1/2"	1 7/8"	35
AMFR-500-750	1/2"	3/4"	1 7/8"	35
AMFR-500-1000	1/2"	1"	1 7/8"	25
AMFR-500-1500	1/2"	1 1/2"	1 7/8"	20
AMFR-500-2000	1/2"	2"	2 5/8"	20
AMFR-580-500	5/8"	1/2"	1 3/8"	25
AMFR-580-750	5/8"	3/4"	1 5/8"	35
AMFR-580-1000	5/8"	1"	2 1/8"	25
AMFR-580-1500	5/8"	1 1/2"	1 5/8"	25
AMFR-580-2000	5/8"	2"	3 1/8"	25
AMFR-750-500	3/4"	1/2"	1 7/8"	25
AMFR-750-750	3/4"	3/4"	2"	25
AMFR-750-1000	3/4"	1"	2"	25
AMFR-750-1500	3/4"	1 1/2"	2 3/8"	25
AMFR-750-2000	3/4"	2"	3 1/8"	14
AMFR-780-500	7/8"	1/2"	2 3/8"	25
AMFR-780-1500	7/8"	1 1/2"	2 3/8"	17

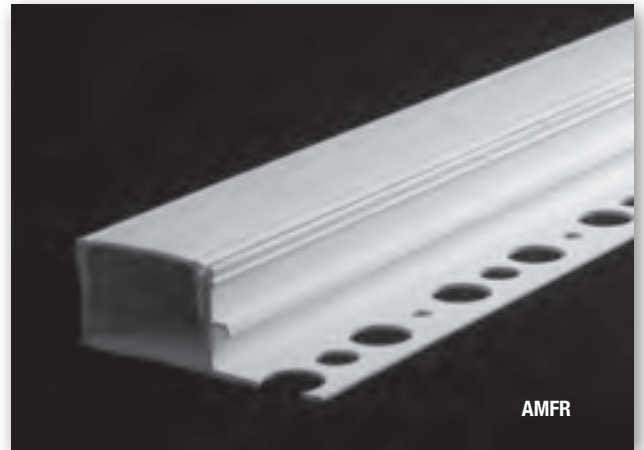

Shown here with temporary cap



NOTE: All joints should be embedded in sealant and sealed after installation if necessary.

These products were introduced to satisfy the demand for innovative and creative stucco accessories. When used with angled casing beads of the same design, the entire look of the stucco assembly is enhanced. Reveals are not to be considered or used as control joints. 10' standard length.

Angled Stucco Reveal creates a unique architectural break in the surface area of a stucco wall. This profile has an improved mechanism for stucco embedment, allowing a better bond between the stucco and the joint to help reduce separation at this location. To function properly, the stucco should be forced under the lip of the bead. (Patent# D456,528S)

Product No.	Ground	Box Count
AMSRA-750	3/4"	25

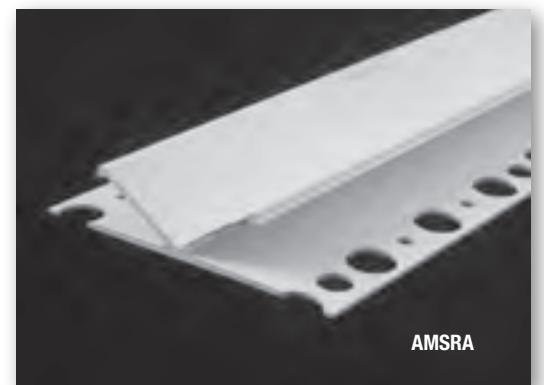

STUCCO REVEALS

Chamfered Reveal is used to provide an architecturally pleasing break in the surface area of a stucco wall. Chamfered reveals are an improvement over standard stucco reveals in that they offer a new, more appealing look to the design and an improved mechanism for stucco embedment. This will improve the bond between the stucco and the joint to help reduce separation at these location. to function properly, the stucco should be forced under the lip of the bead. (Patent# D456,528S)

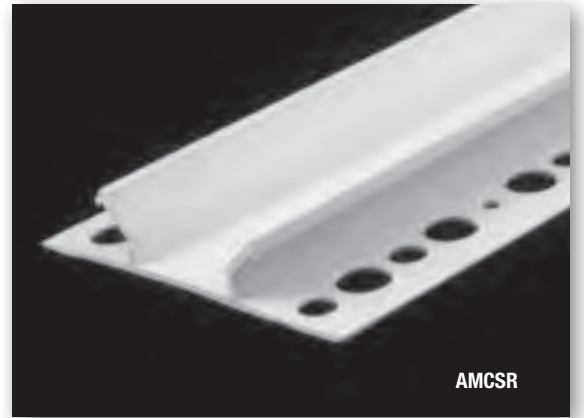

AMCSR



Product No.	Ground A	Reveal B	Width C	Box Count
AMCSR-580-1000	5/8"	1"	2"	25
AMCSR-580-1500	5/8"	1 1/2"	2 1/2"	25
AMCSR-780-1000	7/8"	1"	2"	20

Drip Screed Reveal provides a consistent reveal and ground for soffit applications. 10' standard length.

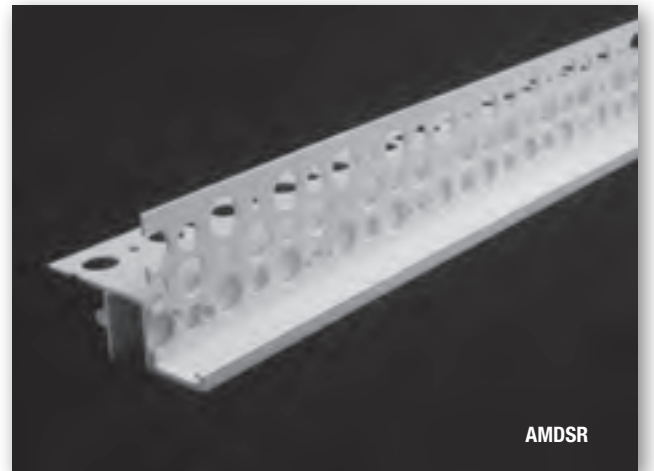

AMDSR



Product No.	Ground A	Reveal B	Box Count
AMDSR-500-500	1/2"	1/2"	10
AMDSR-500-750	1/2"	3/4"	10
AMDSR-500-1000	1/2"	1"	10
AMDSR-500-1500	1/2"	1 1/2"	9
AMDSR-500-2000	1/2"	2"	9
AMDSR-580-500	5/8"	1/2"	10
AMDSR-580-750	5/8"	3/4"	10
AMDSR-580-1000	5/8"	1"	10
AMDSR-580-1500	5/8"	1 1/2"	9
AMDSR-580-2000	5/8"	2"	9
AMDSR-750-500	3/4"	1/2"	9
AMDSR-750-750	3/4"	3/4"	10
AMDSR-750-1000	3/4"	1"	10
AMDSR-750-1500	3/4"	1 1/2"	9
AMDSR-750-2000	3/4"	2"	9
AMDSR-780-1500	7/8"	1 1/2"	9

Window and Door Drip Edge is used to provide added protection for system edges at the top of windows and doors. This product has a drip edge which helps direct water away from the building. Also ideal for thin veneer stone applications. 10' standard length.

Product No.	Attachment Flange "A"	Board Thickness	Finish Thickness	Box Count
AMWDE-75-16	2"	3/4"	1/16"	100
AMWDE-100-16	2"	1"	1/16"	100
AMWDE-100-25*	2"	1"	1/4"	70
AMWDE-150-16	2"	1 1/2"	1/16"	80
AMWDE-150-25	2"	1 1/2"	1/4"	60
AMWDE-200-16	2"	2"	1/16"	75
AMFDE-200-25*	3 1/2"	2"	1/4"	50



TAN



BROWN



GRAY



AMWDE

2-Piece Shadow Reveal form reveals from 1/2" to 1-1/4" while providing for expansion and contraction at the juncture of the wall and ceiling. This accessory is designed to relieve stress caused by normal stucco shrinkage and thermal movement. 10' standard length.

Product No.	Reveal	Vertical Leg A	Ground B	Box Count
AMESR-500-750	Adjustable 1/2" to 3/4"	1"	1/2"	20
AMESR-580-750	Adjustable 1/2" to 3/4"	1"	5/8"	20
AMESR-750-750	Adjustable 1/2" to 3/4"	1"	3/4"	20
AMESR-780-750	Adjustable 1/2" to 3/4"	1"	7/8"	20

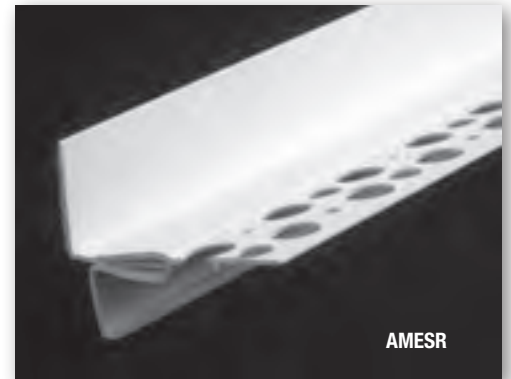

AMESR

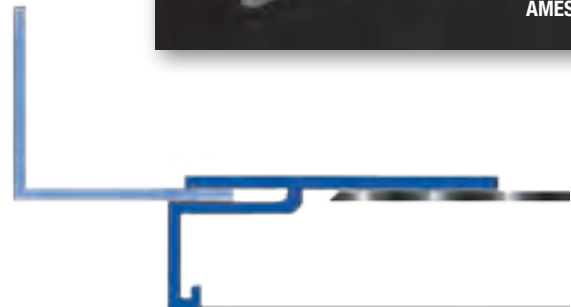

NOTES:

These vinyl items may not all be in stock and require additional lead time. Please contact AMICO to determine availability.

All joints should be embedded in sealant and sealed after installation if necessary.

Items are assembled after order is placed and require additional lead time.

STUCCO SOFFIT VENTS

Vinyl Continuous Stucco Soffit Vent (1-Piece) is a continuous one-piece vent for stucco applications in soffit areas, used to allow for attic ventilation. Beads located at the edges of this product act as casing beads, providing a screed surface for stucco application. Clips are provided to aid in proper alignment of multiple sections. 10' standard length.

Product No.	Overall Width	Vent Width A	Vent Open Area (per lineal ft.)	Percent Open Area (Actual)	Ground B	Box Count
AMSVS-200-500	3 3/4"	2"	6.6 square in.	27.6	1/2"	15
AMSVS-200-580	3 3/4"	2"	6.6 square in.	27.6	5/8"	15
AMSVS-200-750	3 3/4"	2"	6.6 square in.	27.6	3/4"	15
AMSVS-200-780	3 3/4"	2"	6.6 square in.	27.6	7/8"	13
AMSVS-300-500	4 3/4"	3"	9.6 square in.	26.6	1/2"	15
AMSVS-300-580	4 3/4"	3"	9.6 square in.	26.6	5/8"	15
AMSVS-300-750	4 3/4"	3"	9.6 square in.	26.6	3/4"	15
AMSVS-300-780	4 3/4"	3"	9.6 square in.	26.6	7/8"	13
AMSVS-400-500	5 3/4"	4"	14.0 square in.	29.1	1/2"	15
AMSVS-400-580	5 3/4"	4"	14.0 square in.	29.1	5/8"	15
AMSVS-400-750	5 3/4"	4"	14.0 square in.	29.1	3/4"	15
AMSVS-400-780	5 3/4"	4"	14.0 square in.	29.1	7/8"	13

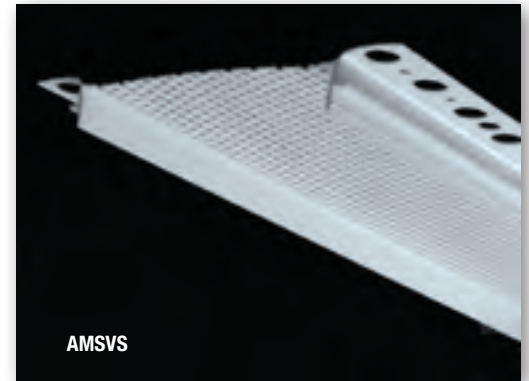

Vinyl Continuous Stucco Shadow Vent (1-Piece) allows installation of a vent against the fascia surface to prevent difficulty of centering the vent in the soffit. Clips are provided to aid in proper alignment of multiple sections. 10' standard length.

Product No.	Overall Width	Vent Width A	Vent Open Area (per lineal ft.)	Percent Open Area (Actual)	Ground B	Box Count
AMSVSR-200-500	3"	2"	6.6 square in.	27.6	1/2"	15
AMSVSR-200-580	3"	2"	6.6 square in.	27.6	5/8"	15
AMSVSR-200-750	3"	2"	6.6 square in.	27.6	3/4"	15
AMSVSR-200-780	3"	2"	6.6 square in.	27.6	7/8"	13
AMSVSR-300-500	4"	3"	9.6 square in.	26.6	1/2"	15
AMSVSR-300-580	4"	3"	9.6 square in.	26.6	5/8"	15
AMSVSR-300-750	4"	3"	9.6 square in.	26.6	3/4"	15
AMSVSR-300-780	4"	3"	9.6 square in.	26.6	7/8"	13
AMSVSR-400-500	5"	4"	14.0 square in.	29.1	1/2"	15
AMSVSR-400-580	5"	4"	14.0 square in.	29.1	5/8"	15
AMSVSR-400-750	5"	4"	14.0 square in.	29.1	3/4"	15
AMSVSR-400-780	5"	4"	14.0 square in.	29.1	7/8"	13

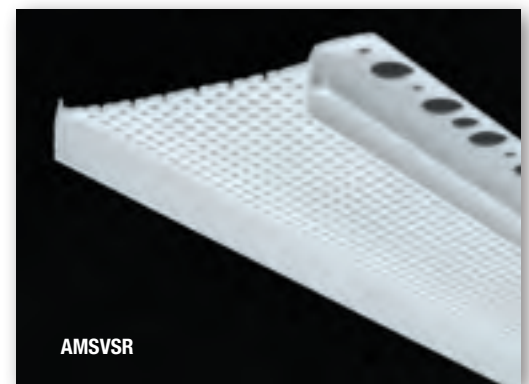

Vinyl Stucco Soffit Vent (3-Piece) is a continuous three-piece vent for stucco applications in soffit areas, used to allow for attic ventilation. The three-piece vent also allows for expansion and contraction in these areas. The two outside casing type components provide grounds that match the thickness of the stucco and can be used as screeds. Clips are provided to aid in proper alignment of multiple sections. 10' standard length.

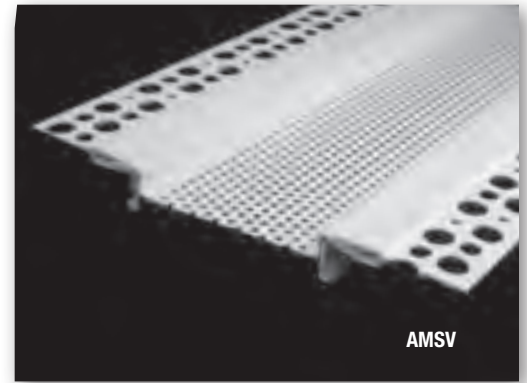

Product No.	Overall Width	Vent Width A	Vent Open Area (per lineal ft.)	Percent Open Area (Actual)	Ground B	Box Count
AMSV-500-200	6 1/8"	2"	6.6 square in.	27.6	1/2"	13
AMSV-580-200	6 1/8"	2"	6.6 square in.	27.6	5/8"	13
AMSV-750-200	6 1/8"	2"	6.6 square in.	27.6	3/4"	11
AMSV-780-200	6 1/8"	2"	6.6 square in.	27.6	7/8"	10
AMSV-500-300	7 1/8"	3"	9.6 square in.	26.6	1/2"	13
AMSV-580-300	7 1/8"	3"	9.6 square in.	26.6	5/8"	13
AMSV-750-300	7 1/8"	3"	9.6 square in.	26.6	3/4"	11
AMSV-780-300	7 1/8"	3"	9.6 square in.	26.6	7/8"	10
AMSV-500-400	8 1/8"	4"	14.0 square in.	29.1	1/2"	13
AMSV-580-400	8 1/8"	4"	14.0 square in.	29.1	5/8"	13
AMSV-750-400	8 1/8"	4"	14.0 square in.	29.1	3/4"	11
AMSV-780-400	8 1/8"	4"	14.0 square in.	29.1	7/8"	10

NOTES:

All joints should be embedded in sealant and sealed after installation if necessary.

Items are assembled after order is placed and require additional lead time.

SOFFIT VENT PANELS

Vinyl Soffit Vent Panels provide ventilation in the soffit to prevent condensation while providing casing beads for surrounding stucco applications. Specify quantity.

Product No.	Ground	Width B	Surface Area (sq. in.)
AMSVS-P-200-500	1/2"	2"	48"
AMSVS-P-200-580	5/8"	2"	48"
AMSVS-P-200-750	3/4"	2"	48"
AMSVS-P-200-780	7/8"	2"	48"
AMSVS-P-300-500	1/2"	3"	72"
AMSVS-P-300-580	5/8"	3"	72"
AMSVS-P-300-750	3/4"	3"	72"
AMSVS-P-300-780	7/8"	3"	72"
AMSVS-P-400-500	1/2"	4"	96"
AMSVS-P-400-580	5/8"	4"	96"
AMSVS-P-400-750	3/4"	4"	96"
AMSVS-P-400-780	7/8"	4"	96"

24" Soffit Vent Panels

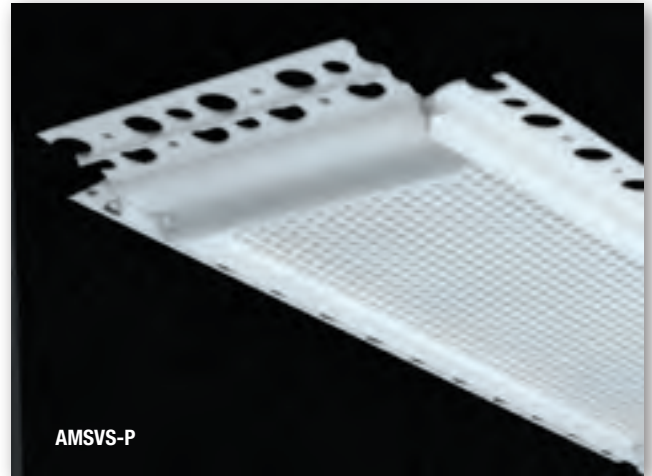

Vinyl Shadow Vent Panels are designed for stucco applications that require an architectural reveal and venting at the soffit. Specify quantity.

Product No.	Ground	Width B	Surface Area (sq. in.)
AMSVSR-P-200-500	1/2"	2"	48"
AMSVSR-P-200-580	5/8"	2"	48"
AMSVSR-P-200-750	3/4"	2"	48"
AMSVSR-P-200-780	7/8"	2"	48"
AMSVSR-P-300-500	1/2"	3"	72"
AMSVSR-P-300-580	5/8"	3"	72"
AMSVSR-P-300-750	3/4"	3"	72"
AMSVSR-P-300-780	7/8"	3"	72"
AMSVSR-P-400-500	1/2"	4"	96"
AMSVSR-P-400-580	5/8"	4"	96"
AMSVSR-P-400-750	3/4"	4"	96"
AMSVSR-P-400-780	7/8"	4"	96"

24" Shadow Vent Panels

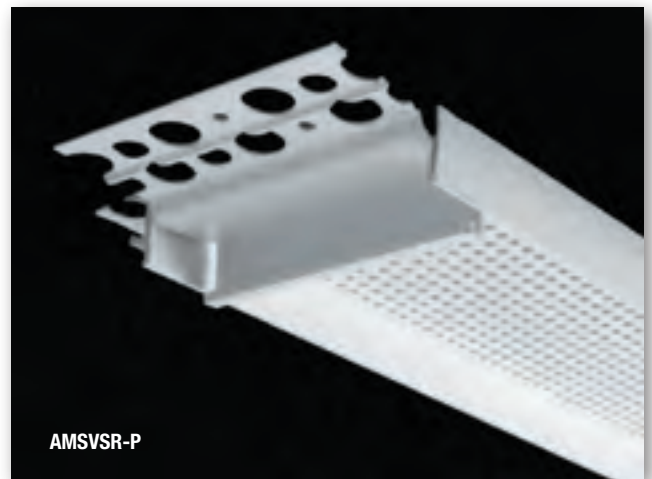

NOTES:

All joints should be embedded in sealant and sealed after installation if necessary.
Items are assembled after order is placed and require additional lead time.



AMICO locations

UNITED STATES

Birmingham, AL
800-366-2642

Bourbonnais, IL
800-238-0322

Dayton, TX
800-622-5765

Fontana, CA
800-962-0100

Houston, TX
800-433-9945

Lakeland, FL
800-487-2511

Orem, UT
800-645-0340

CANADA

Burlington, ON
800-663-4474

Edmonton, AB
855-724-7283

Montreal, QC
800-463-3255

Vancouver, BC
800-665-4474

Seasafe

Lafayette, LA
800-326-8842

Diamond Perforated

Visalia, CA
800-642-4334

Erdle Perforated

Charlotte, NC
800-438-4467

Rochester, NY
800-627-4700

The Expanded Metal
Company, LTD

Hartlepool, England
+44 (0) 1429 867 388

SORST Streckmetall

Hannover, Germany
+49 (5 11) 67 67 56-0



Visit www.amicoglobal.com to view or download data sheets, request a catalog, request LEED information or receive technical assistance.



A GIBRALTAR INDUSTRIES COMPANY 